

CAST IN MOUNT STANDARD
 BLOCKOUT MOUNT OPTIONAL
 SPECIFY IF REQUIRED _____

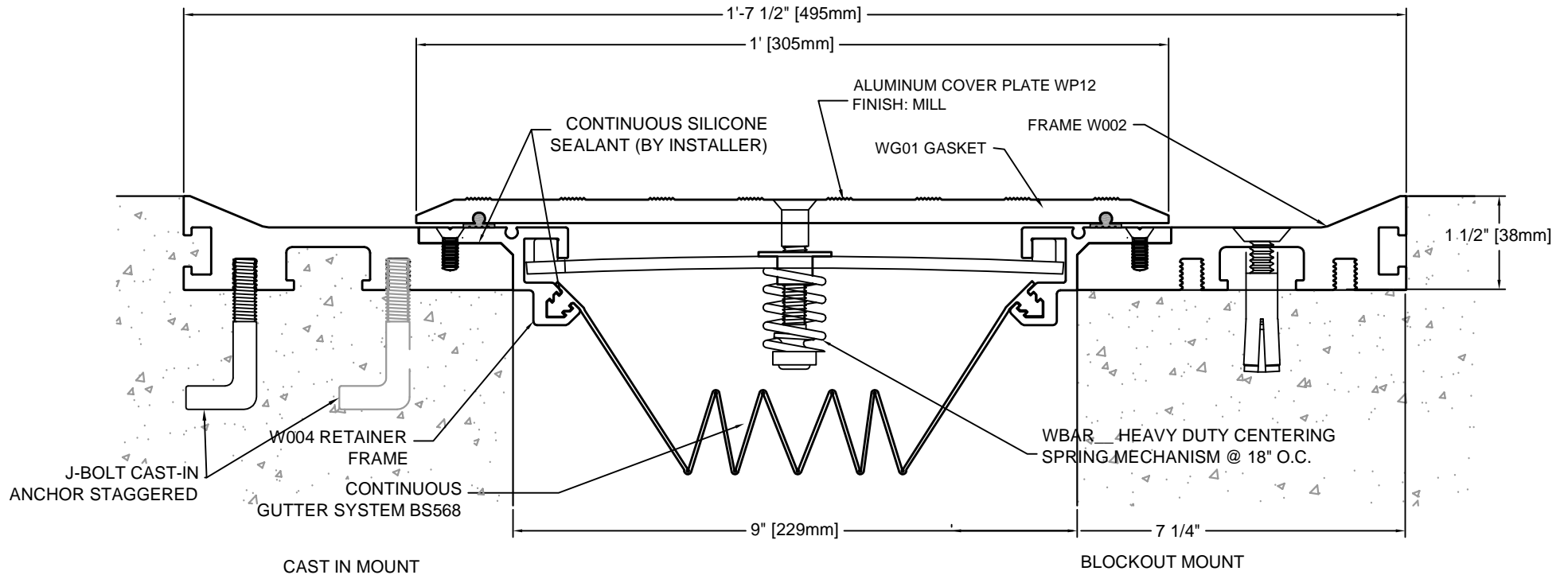

DESCRIPTION: FLOOR-TO-FLOOR
 ALUMINUM: 6061-T6
 SEALS: TPE 591-65A
 EXPOSED FINISH: MILL
 MOVEMENT: PLUS OR MINUS 50%
 STOCK LENGTHS: 10'-0"

W90-CI-AL
 FORMERLY W90-22-11



**Architectural Art
 MANUFACTURING**

Division of Pittcon Architectural Metals, LLC
 283 SWANSON DRIVE, STE 103
 LAWRENCEVILLE, GA 30043
 PH: (678) 680-7373 FAX: (678) 735-0085
 TOLL FREE: (800) 835-0028 web: www.archart.com

CAST-IN FLOOR - FLOOR SYSTEM

MODEL: W90-CI-AL

DRAWN BY:
 NDC

SCALE:
 NTS

DRAWING NO.:

SHT. 1 OF 1

ISSUE DATE:
 6/10/09

DTL-01

NO.	DESCRIPTION	BY	DATE

REVISIONS

The information contained herein is the proprietary property of **ARCHITECTURAL ART MFG.**, Division of Pittcon Architectural Metals, LLC. No portion of it may be reproduced by any means or used in any form except for the purpose for which it was furnished. All rights of design and invention are hereby reserved. We reserve the right to make changes in the design at our discretion.