

COLOR SELECTION:

BLACK, LIMESTONE, DUSTY
ROSE, BRONZE, PRECAST WHITE,
RUSTIC BRICK, SANDSTONE, NATURAL
STONE, BLUE SPRUCE, ADOBE TAN,
GRAY, CHARCOAL

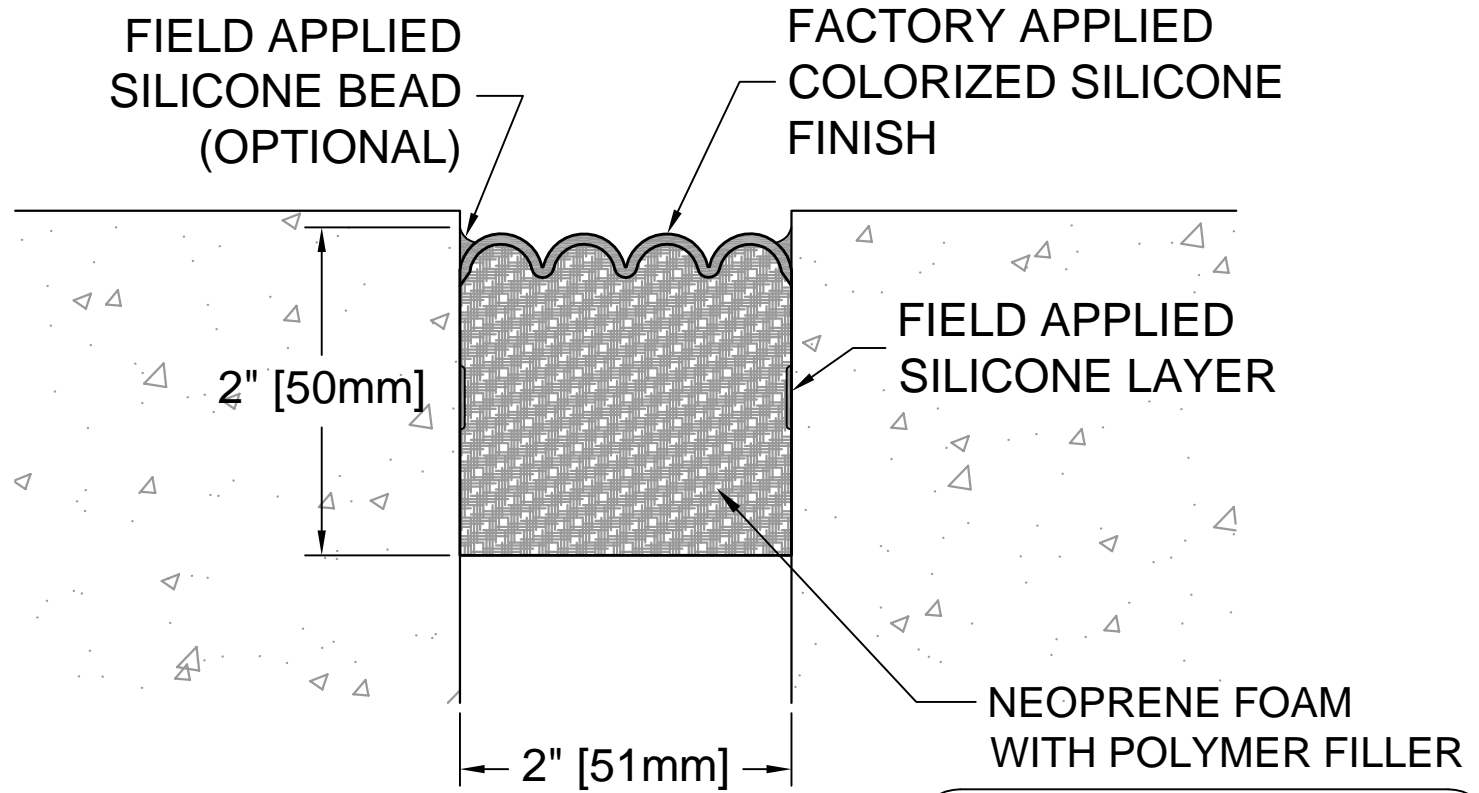

DESCRIPTION: WALL TO WALL (EXTERIOR)
EXPOSED FINISH: SILICONE
MOVEMENT: PLUS OR MINUS 50% JOINT WIDTH
STOCK LENGTHS: 5'-0"

W20-SA-SI
Formerly W20-52-81



**Architectural Art
MANUFACTURING**

Division of Pittcon Architectural Metals, LLC
283 SWANSON DRIVE, STE 103
LAWRENCEVILLE, GA 30043
PH: (678) 680-7373 FAX: (678) 735-0085
TOLL FREE: (800) 835-0085 web: www.archart.com

RIGHTS OF DESIGN

All rights of design, detail, engineering and/or invention contained herein are the property of Architectural Art Mfg. and hereby are the property and are not to be reproduced or provided to any other party. Architectural Art Mfg. reserves the right to amend or withdraw any information contained herein without notice and will not be liable for any inaccuracy or ambiguity of said information.

EXTERIOR WALL SYSTEM

MODEL: W20-SA-SI

DRAWN BY:
NDC

SCALE:
NTS

DRAWING NO.:

SHT. 1 OF 1

ISSUE DATE:
06/01/09

DTL-01