

# T30-81-69

REV. 8/06

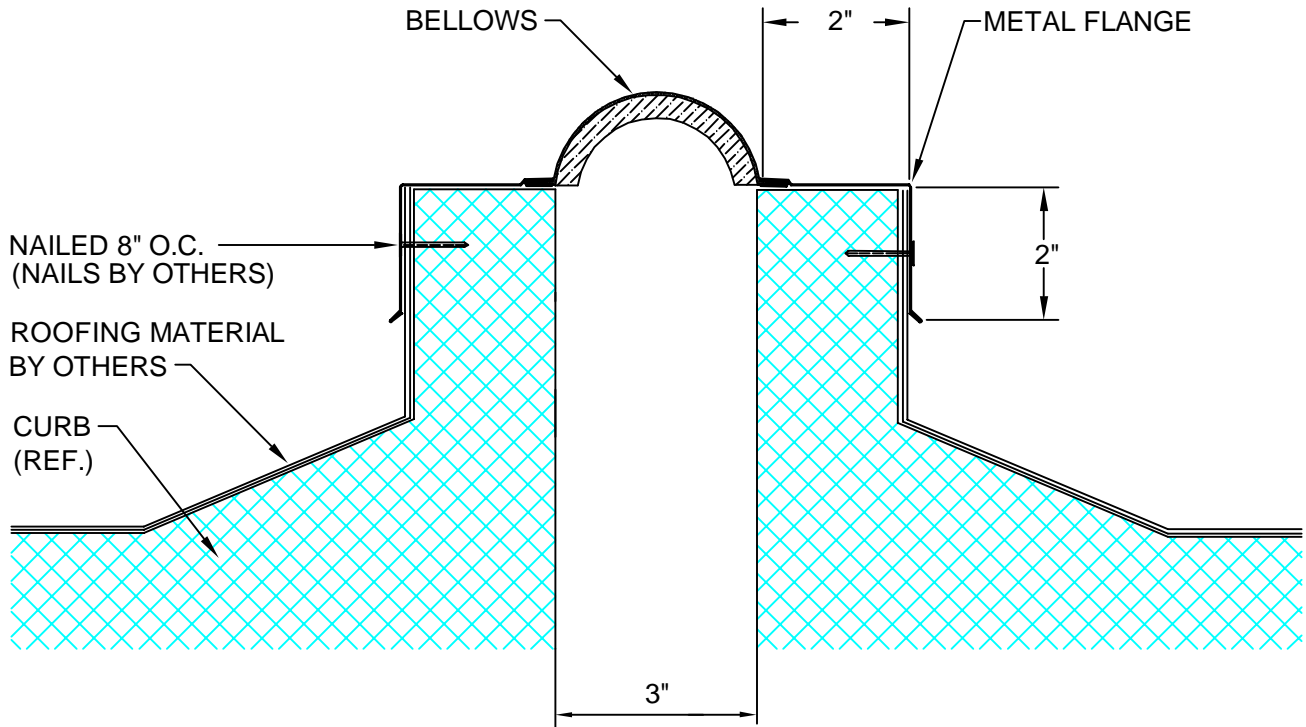

DESCRIPTION: ROOF-TO-ROOF BELLOWS

FLANGE: 16 OZ (.020") COPPER

BELLOWS: 60 MIL BLACK EPDM

EXPOSED FINISH: MILL

ALLOWABLE LOAD: NOT DESIGNED FOR STRUCTURAL LOADS

MOVEMENT: +/- 100% JOINT WIDTH

STOCK LENGTH: 10'-0"

CUSTOMER:		
PROJECT:		
LOCATION:		
ARCHITECT:		
CONTRACTOR:		
NOTE:		
JOB NO.:	DATE:	SCALE: (NTS)

LENGTH:	QTY:	COLOR/FINISH:



**ARCHITECTURAL ART MFG., INC.**

6409 RHODE ISLAND AVE. RIVERDALE, MD 20737

