

T30-81-68

REV. 8/06

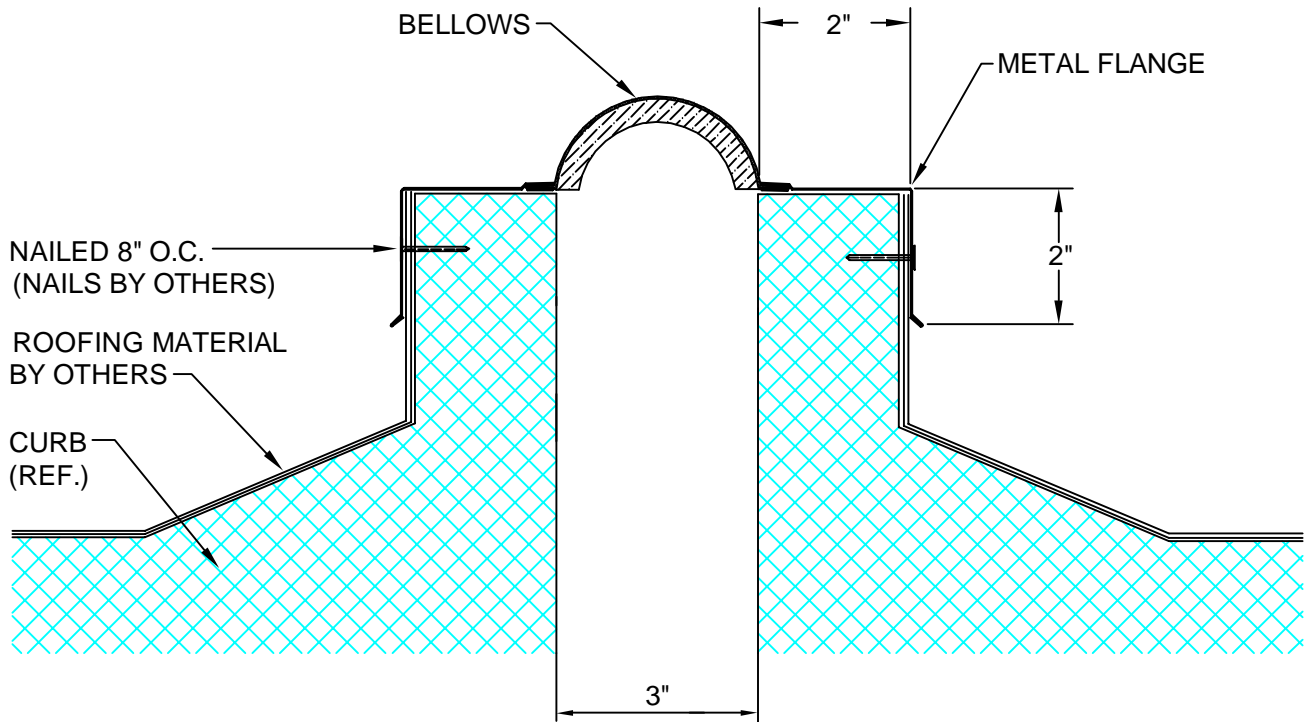

DESCRIPTION: ROOF-TO-ROOF BELLOWS
 FLANGE: 16 OZ (.020") COPPER
 BELLOWS: 60 MIL BLACK NEOPRENE
 EXPOSED FINISH: MILL
 ALLOWABLE LOAD: NOT DESIGNED FOR STRUCTURAL LOADS
 MOVEMENT: +/- 100% JOINT WIDTH
 STOCK LENGTH: 10'-0"

CUSTOMER:		
PROJECT:		
LOCATION:		
ARCHITECT:		
CONTRACTOR:		
NOTE:		
JOB NO.:	DATE:	SCALE: (NTS)

LENGTH:	QTY:	COLOR/FINISH:



ARCHITECTURAL ART MFG., INC.

6409 RHODE ISLAND AVE. RIVERDALE, MD 20737

