

COLOR SELECTOR	
BLACK _____	BROWN _____
BEIGE _____	GRAY _____
WHITE _____	

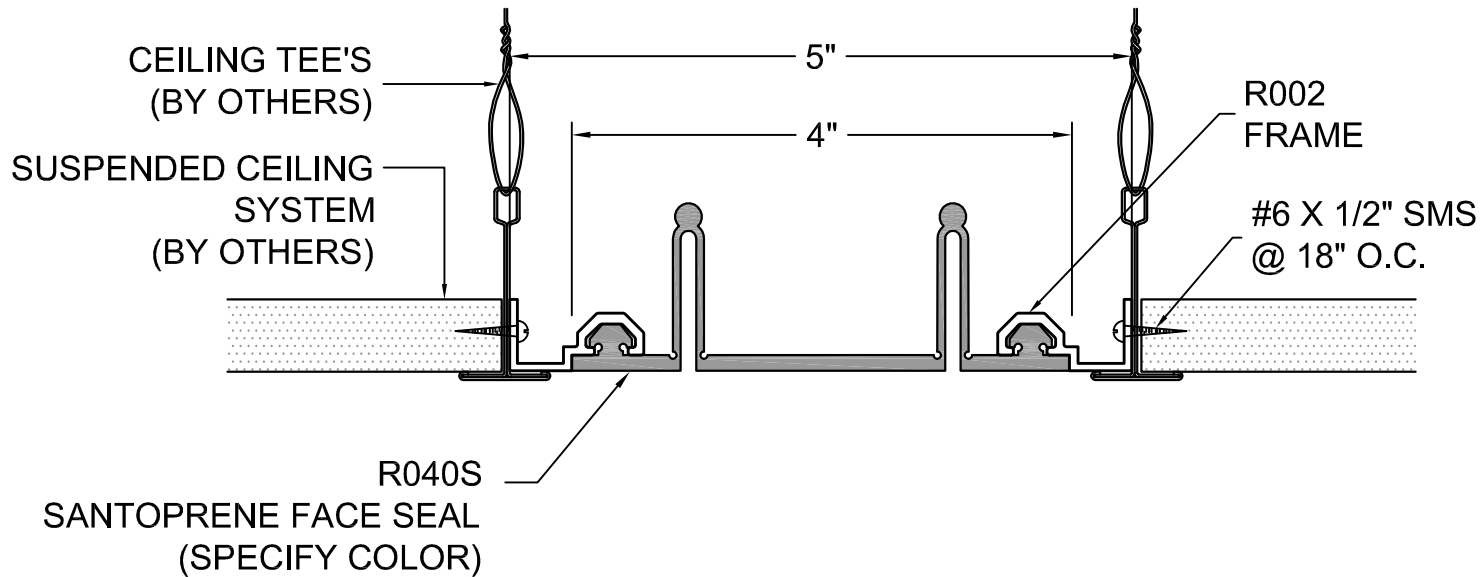

DESCRIPTION: INTERIOR FLAT CEILING SYSTEM

- ALUMINUM: 6063-T5 EXTRUSION
- FACE SEAL: SANTOPRENE
- MOVEMENT: +100% TENSION/COMPRESSION TO 1 1/4"
- STOCK LENGTHS: 10'-0" OR 20'-0" ALUMINUM; SEAL: CONTINUOUS

R40-71-94



**Architectural Art
MANUFACTURING**

Division of Pittcon Architectural Metals, LLC

283 SWANSON DRIVE, STE 103
LAWRENCEVILLE, GA 30043
PH: (678) 680-7373 FAX: (678) 735-0085
TOLL FREE: (800) 835-0028 web: www.archart.com

CL/CL FLAT INTERIOR SYSTEM

MODEL: R40-71-94

DRAWN BY:
DOC

SCALE:
NTS

DRAWING NO.:

SHT. 1 OF 1

ISSUE DATE:
01/07/11

DTL-01

NO.	DESCRIPTION	BY	DATE

REVISIONS

The information contained herein is the proprietary property of **ARCHITECTURAL ART MFG.**, Division of Pittcon Architectural Metals, LLC. No portion of it may be reproduced by any means or used in any form except for the purpose for which it was furnished. All rights of design and invention are hereby reserved. We reserve the right to make changes in the design at our discretion.