

M00-23-11

REV. 7/06

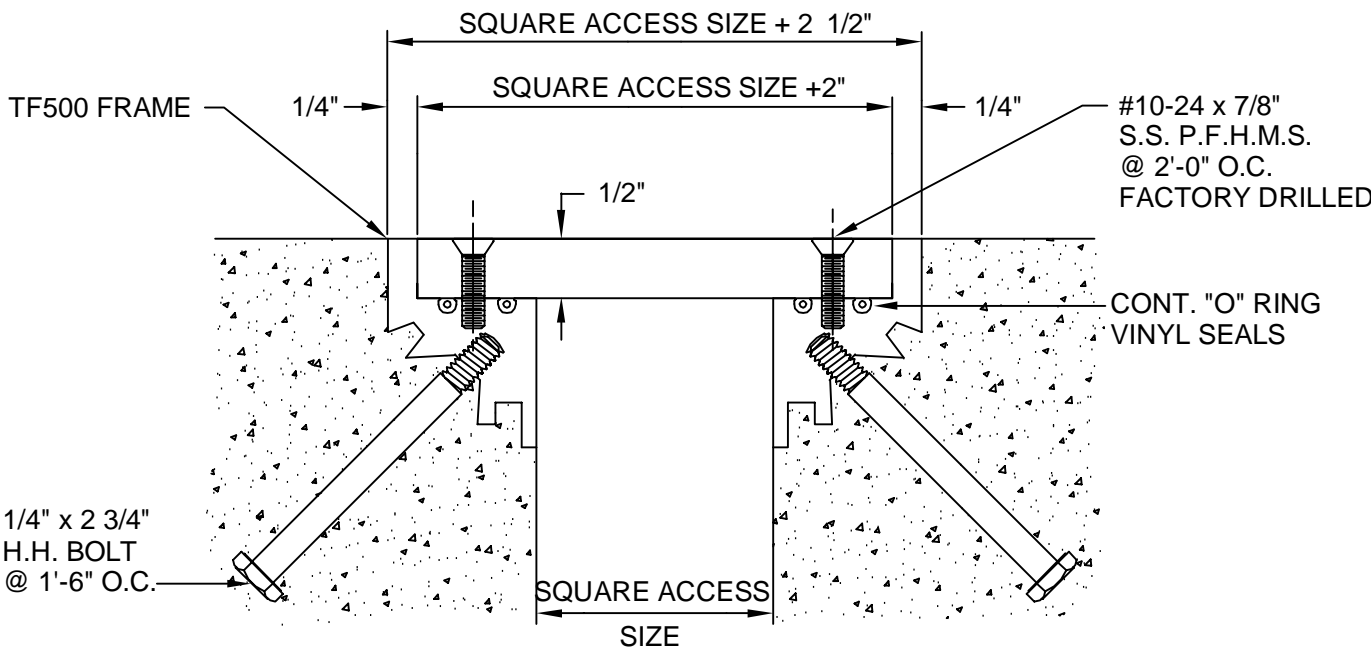

ALUMINUM: 6063-T5 EXTRUSION, 6061-T6 PLATE
 EXPOSED FINISH: MILL
 ZINC CHROMATE AREAS IN CONTACT W/ WET CEMENT
 ALLOWABLE LOAD: CALL FACTORY: 800-835-0028
 SEALS: 70 DURO. VINYL

CUSTOMER:		
PROJECT:		
LOCATION:		
ARCHITECT:		
CONTRACTOR:		
NOTE:		
JOB NO.:	DATE:	SCALE: (NTS)

LENGTH:	QTY:	COLOR/FINISH:

ARCHITECTURAL ART MFG., INC.

6409 RHODE ISLAND AVE. RIVERDALE, MD 20737