

# L180-92-11

REV. 7/06

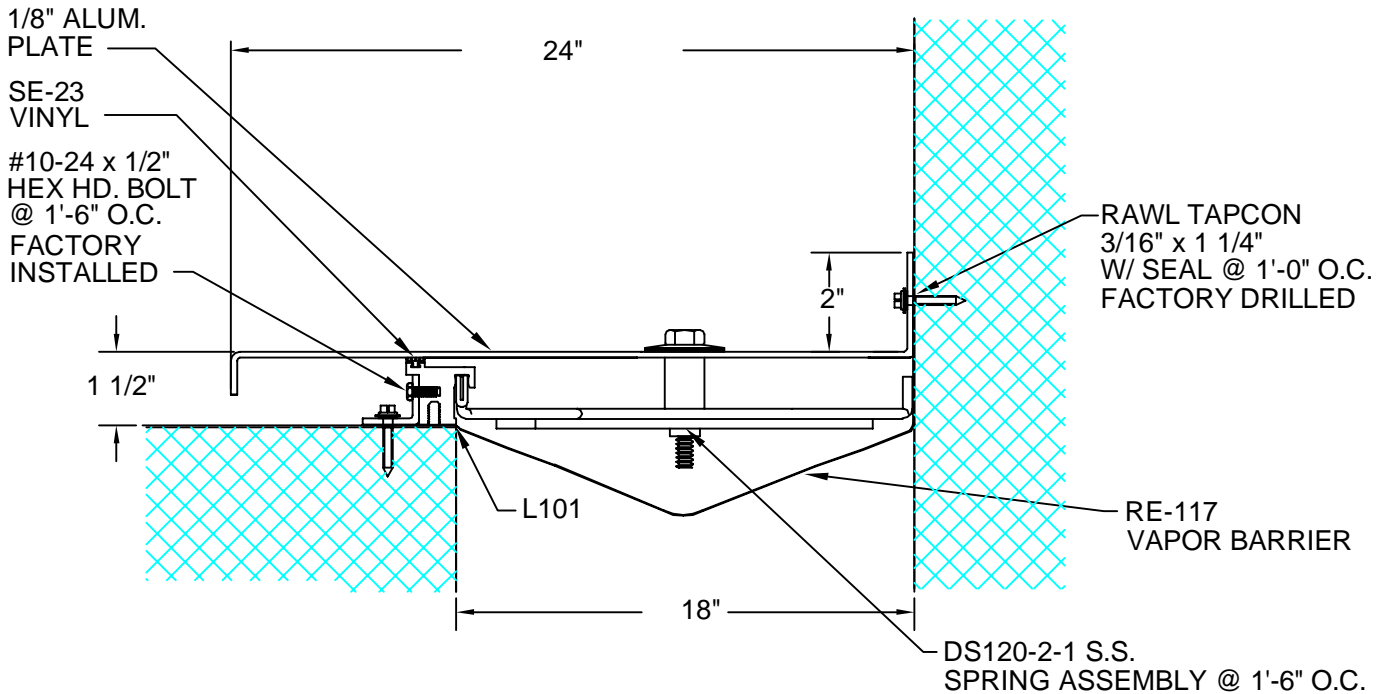

DESCRIPTION: EXTERIOR CORNER WALL/WALL  
 ALUMINUM: 6063-T5 EXTRUSION, 6061-T6 PLATE  
 STAINLESS STEEL: 304 ALLOY  
 EXPOSED FINISH: MILL  
 ALLOWABLE LOAD: NOT DESIGNED FOR STRUCTURAL LOADS  
 MOVEMENT: +/-25 % JOINT WIDTH  
 STOCK LENGTHS: 10'-0"

CUSTOMER:		
PROJECT:		
LOCATION:		
ARCHITECT:		
CONTRACTOR:		
NOTE:		
JOB NO.:	DATE:	SCALE: (NTS)

LENGTH:	QTY:	COLOR/FINISH:



**ARCHITECTURAL ART MFG., INC.**

6409 RHODE ISLAND AVE. RIVERDALE, MD 20737

