

# L160-91-11

REV. 7/06

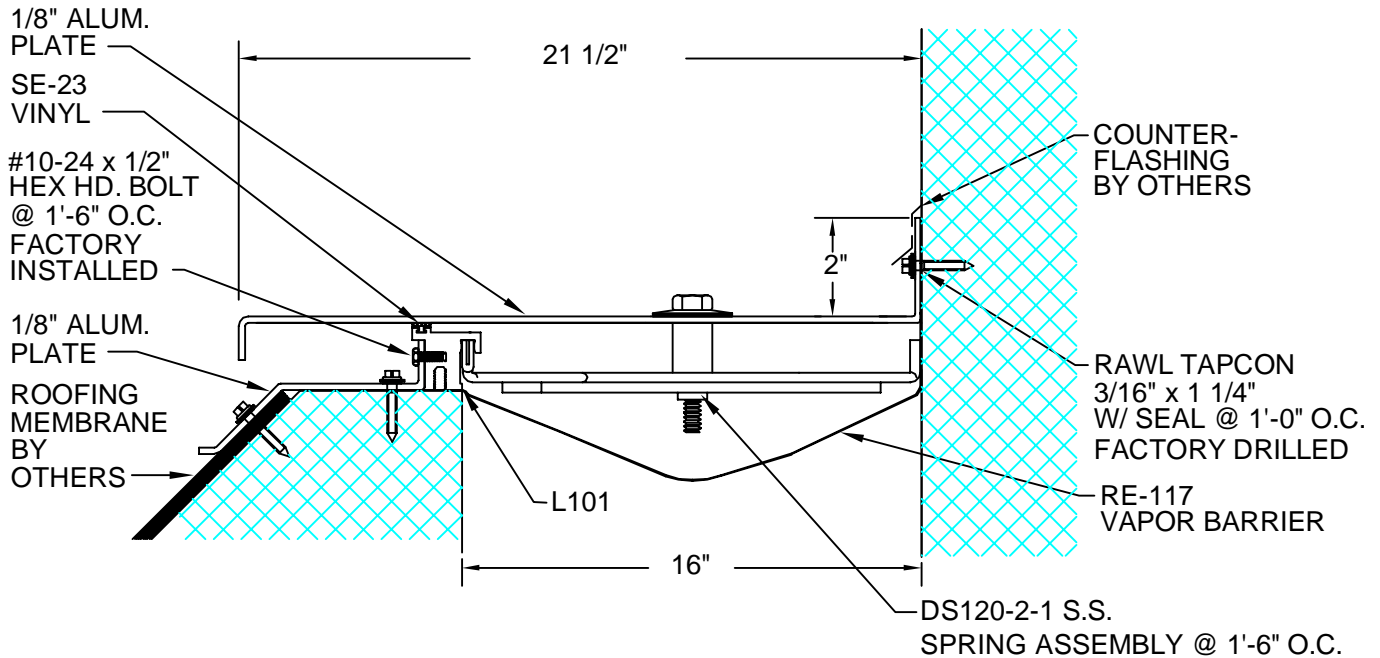

DESCRIPTION: EXTERIOR CORNER ROOF/WALL  
ALUMINUM: 6063-T5 EXTRUSION, 6061-T6 PLATE  
STAINLESS STEEL: 304 ALLOY  
EXPOSED FINISH: MILL  
ALLOWABLE LOAD: NOT DESIGNED FOR STRUCTURAL LOADS  
MOVEMENT: +/- 25% JOINT WIDTH  
STOCK LENGTHS: 10'-0"

CUSTOMER:		
PROJECT:		
LOCATION:		
ARCHITECT:		
CONTRACTOR:		
NOTE:		
JOB NO.:	DATE:	SCALE: (NTS)

LENGTH:	QTY:	COLOR/FINISH:



**ARCHITECTURAL ART MFG., INC.**  
6409 RHODE ISLAND AVE. RIVERDALE, MD 20737

