

# H50-53-24

REV. 2/08

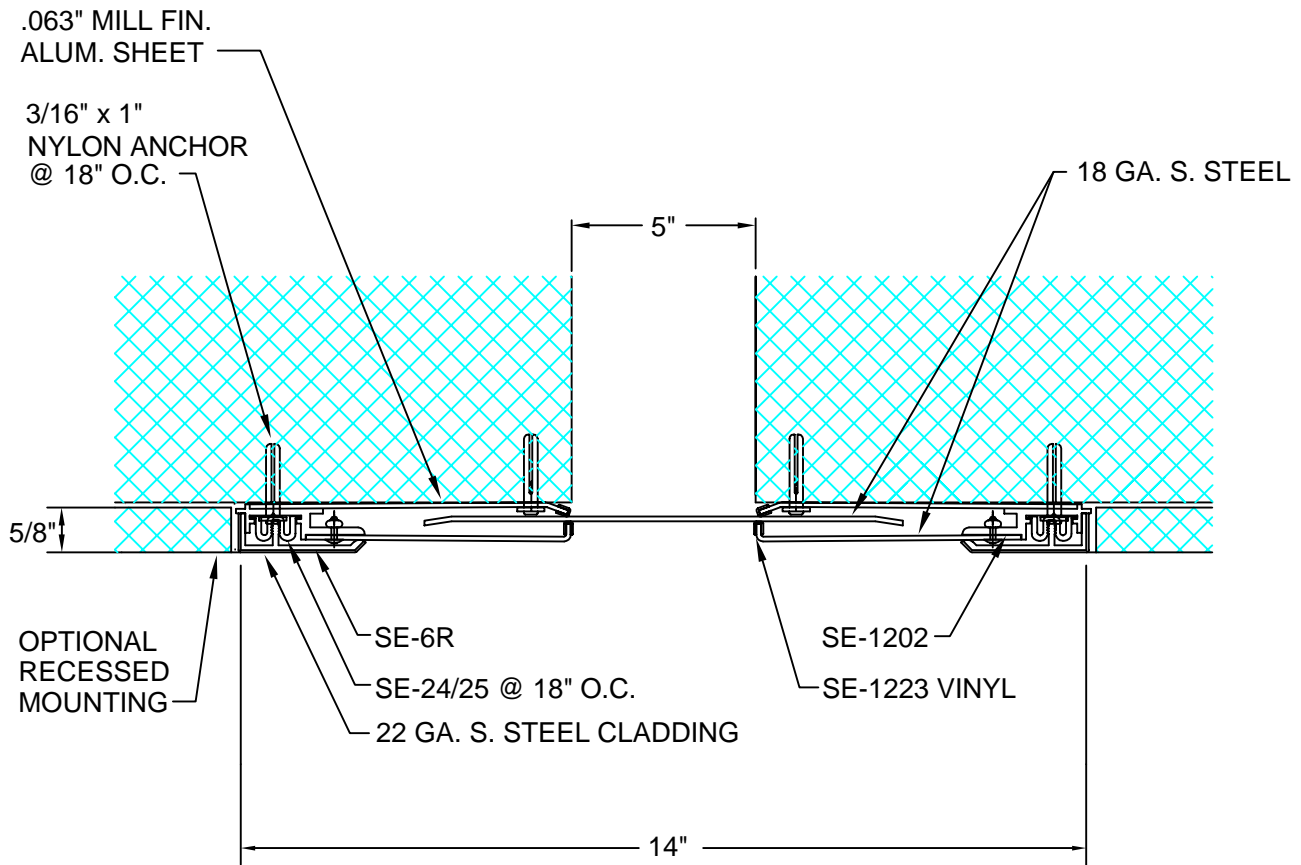

DESCRIPTION: WALL TO WALL; CEILING TO CEILING

ALUMINUM: 6063-T5 EXTRUSION, 3003-H14 SHEET

STAINLESS STEEL: 304 ALLOY

VINYL: 90 DURO PVC

EXPOSED FINISH: #4 SATIN w/ STRIPPABLE PROTECTIVE TAPE

ALLOWABLE LOAD: NOT DESIGNED FOR STRUCTURAL LOADS

MOVEMENT: +/- 50% JOINT WIDTH

STOCK LENGTHS: 10'-0"

CUSTOMER:			MARK:	QTY:	LENGTH:	LOCATION:
PROJECT:						
LOCATION:						
ARCHITECT:						
CONTRACTOR:						
NOTE:						
JOB NO.:	DATE:	SCALE: (NTS)				

## ARCHITECTURAL ART MFG.

6409 RHODE ISLAND AVE. RIVERDALE, MD 20737 PHONE (800) 835-0028 FAX (316) 462-0511 WWW.ARCHART.COM

AAM RESERVES THE RIGHT TO MAKE DESIGN CHANGES, OR TO WITHDRAW ANY DESIGN WITHOUT NOTICE

© COPYRIGHT 2008 AAM