

H30-53-24

REV. 2/08

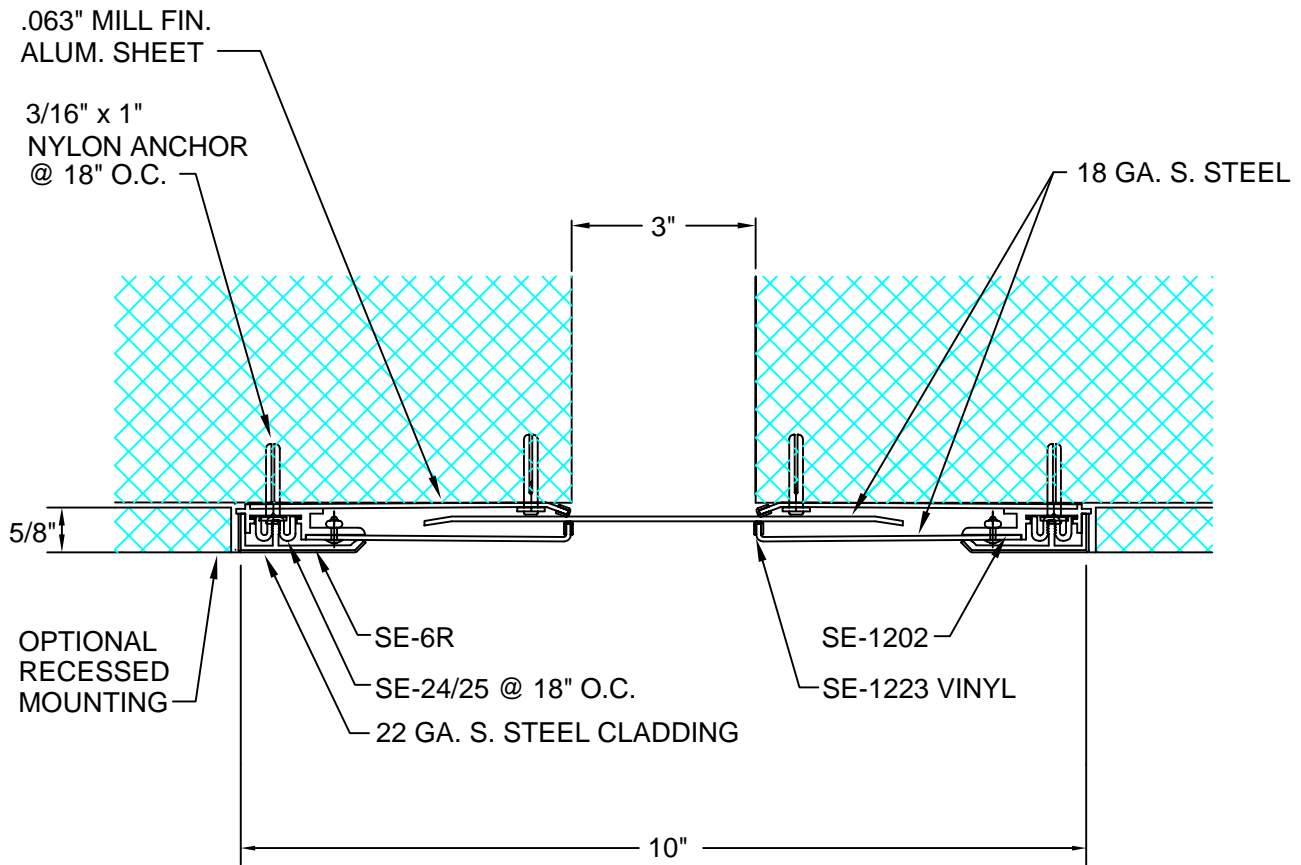

DESCRIPTION: WALL TO WALL; CEILING TO CEILING
 ALUMINUM: 6063-T5 EXTRUSION, 3003-H14 SHEET
 STAINLESS STEEL: 304 ALLOY
 VINYL: 90 DURO PVC
 EXPOSED FINISH: #4 SATIN w/ STRIPPABLE PROTECTIVE TAPE
 ALLOWABLE LOAD: NOT DESIGNED FOR STRUCTURAL LOADS
 MOVEMENT: +/- 50% JOINT WIDTH
 STOCK LENGTHS: 10'-0"

CUSTOMER:		
PROJECT:		
LOCATION:		
ARCHITECT:		
CONTRACTOR:		
NOTE:		
JOB NO.:	DATE:	SCALE: (NTS)

MARK:	QTY:	LENGTH:	LOCATION:

ARCHITECTURAL ART MFG.

6409 RHODE ISLAND AVE. RIVERDALE, MD 20737 PHONE (800) 835-0028 FAX (316) 462-0511 WWW.ARCHART.COM

AAM RESERVES THE RIGHT TO MAKE DESIGN CHANGES, OR TO WITHDRAW ANY DESIGN WITHOUT NOTICE

© COPYRIGHT 2008 AAM