

G20-71-14

REV. 7/06

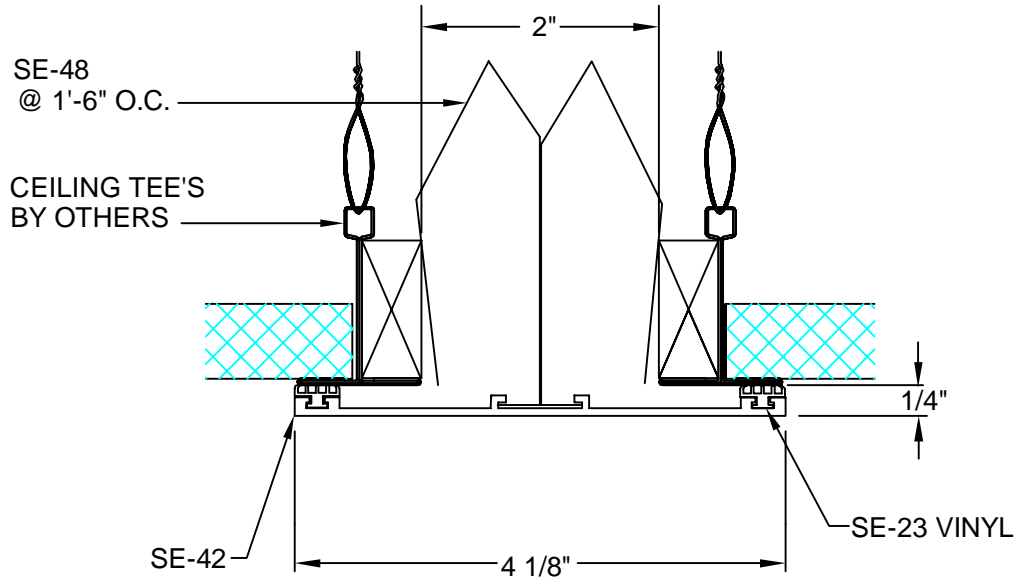

DESCRIPTION: CLIP-IN FLAT WALL/CEILING SYSTEM
 ALUMINUM: 6063-T5 EXTRUSION
 VINYL: 70 DURO. PVC
 EXPOSED FINISH: R1-204 CLEAR ANODIZED
 STRIPPABLE PROTECTIVE TAPE
 ALLOWABLE LOAD: NOT DESIGNED FOR STRUCTURAL LOADS
 MOVEMENT: +/- 50% JOINT WIDTH
 STOCK LENGTHS: 20'-0"

CUSTOMER:		
PROJECT:		
LOCATION:		
ARCHITECT:		
CONTRACTOR:		
NOTE:		
JOB NO.:	DATE:	SCALE: (NTS)

LENGTH:	QTY:	COLOR/FINISH:



ARCHITECTURAL ART MFG., INC.

6409 RHODE ISLAND AVE. RIVERDALE, MD 20737

