

G20-58-14

REV. 7/06

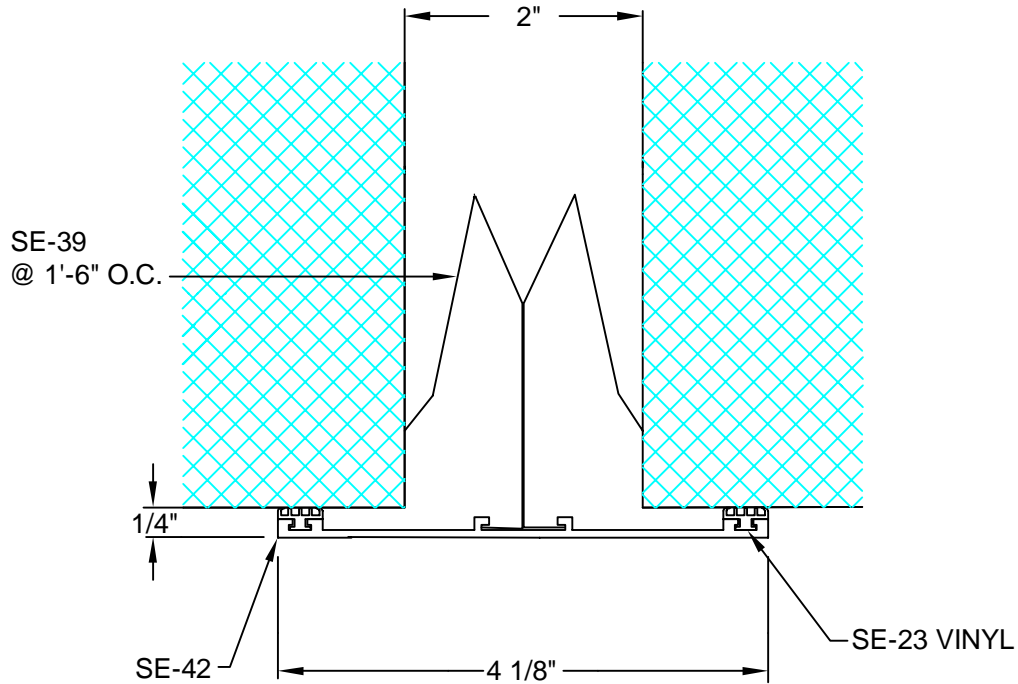

DESCRIPTION: CLIP-IN FLAT WALL/CEILING SYSTEM

ALUMINUM: 6063-T5 EXTRUSION

VINYL: 70 DURO. PVC

EXPOSED FINISH: R1-204 CLEAR ANODIZED
STRIPPABLE PROTECTIVE TAPE

ALLOWABLE LOAD: NOT DESIGNED FOR STRUCTURAL LOADS

MOVEMENT: +/- 50% JOINT WIDTH

STOCK LENGTHS: 20'-0"

CUSTOMER:		
PROJECT:		
LOCATION:		
ARCHITECT:		
CONTRACTOR:		
NOTE:		
JOB NO.:	DATE:	SCALE: (NTS)

LENGTH:	QTY:	COLOR/FINISH:



ARCHITECTURAL ART MFG., INC.

6409 RHODE ISLAND AVE. RIVERDALE, MD 20737

