

COLOR SELECTOR	
BLACK _____	BROWN _____
BEIGE _____	GRAY _____
WHITE _____	

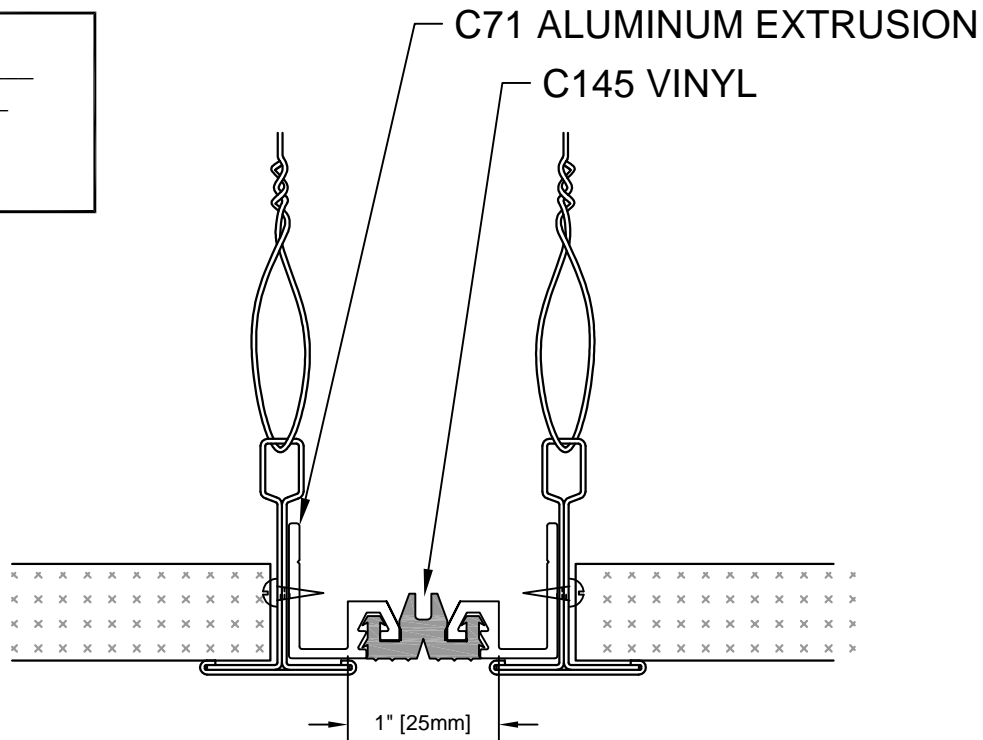

DESCRIPTION: CEILING TO CEILING
 ALUMINUM: 6063-T5 EXTRUSION
 EXPOSED FINISH: MILL
 GROOVED SEAL: VINYL 70 DURO PVC
 SMOOTH SEAL: SANTOPRENE 691 65A
 MOVEMENT: +/- 35% JOINT WIDTH
 STOCK LENGTHS: 10'-0" OR 20'-0"

C10-71-41
 REV. 06/09



**Architectural Art
MANUFACTURING**

Division of Pittcon Architectural Metals, LLC

283 SWANSON DRIVE, STE 103
 LAWRENCEVILLE, GA 30043
 PH: (678) 680-7373 FAX: (678) 735-0085
 TOLL FREE: (800) 835-0028 web: www.archart.com

CLG TO CLG

MODEL: C10-71-41

DRAWN BY:
NDC

SCALE:
NTS

DRAWING NO.:

DTL-01

SHT. 1 OF 1

ISSUE DATE:
06/22/09

NO.	DESCRIPTION	BY	DATE

REVISIONS

The information contained herein is the proprietary property of **ARCHITECTURAL ART MFG.**, Division of Pittcon Architectural Metals, LLC. No portion of it may be reproduced by any means or used in any form except for the purpose for which it was furnished. All rights of design and invention are hereby reserved. We reserve the right to make changes in the design at our discretion.