

COLOR SELECTOR	
BLACK _____	BROWN _____
BEIGE _____	GRAY _____
WHITE _____	

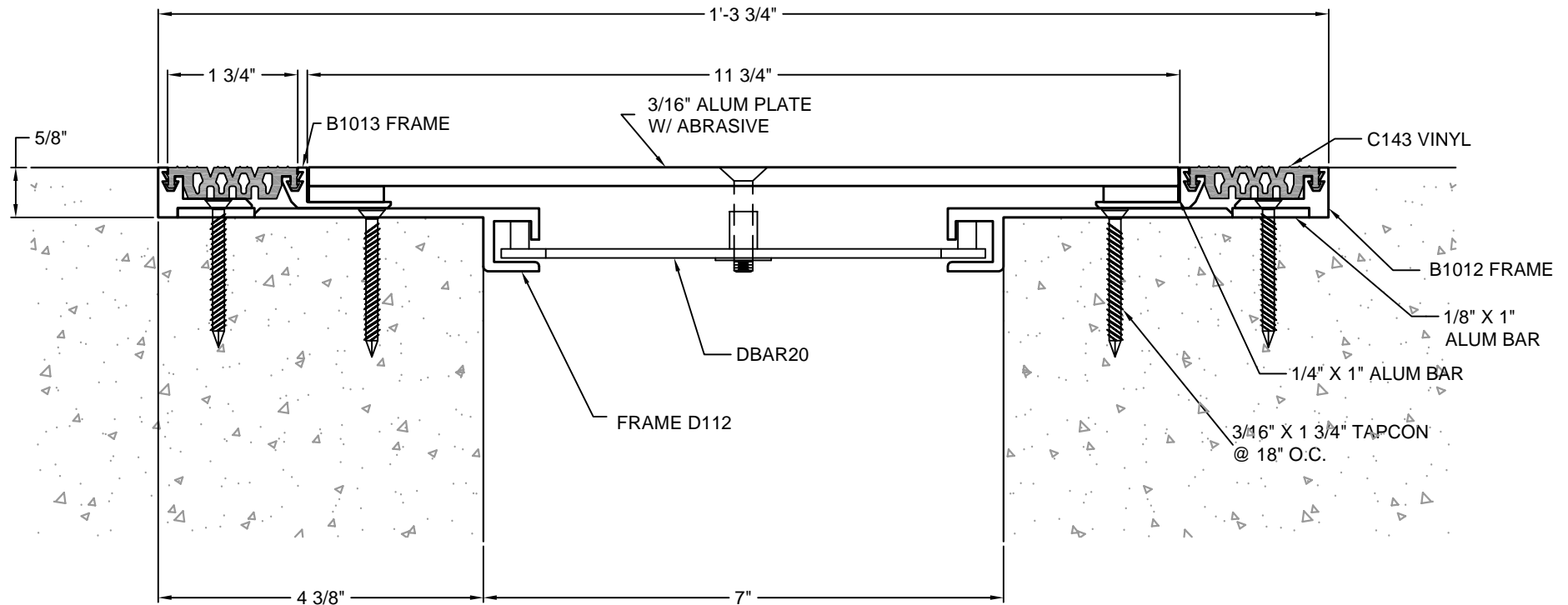

DESCRIPTION: FLOOR-TO-FLOOR
 ALUMINUM: 6063-T5 EXTRUSION
 VINYL: 70 DURO. PVC
 EXPOSED FINISH: ABRASIVE
 MOVEMENT: +/- 50% JOINT WIDTH
 STOCK LENGTHS: 10'-0"

B70-13-11

REV. 08/09



**Architectural Art
 MANUFACTURING**

Division of Pittcon Architectural Metals, LLC
 283 SWANSON DRIVE, STE 103
 LAWRENCEVILLE, GA 30043
 PH: (678) 680-7373 FAX: (678) 735-0085
 TOLL FREE: (800) 835-0028 web: www.archart.com

RIGHTS OF DESIGN

All rights of design, detail, engineering and/or invention contained herein are the property of Architectural Art Mfg. and hereby are the property and are not to be reproduced or provided to any other party. Architectural Art Mfg. reserves the right to amend or withdraw any information contained herein without notice and will not be liable for any inaccuracy or ambiguity of said information.

INTERIOR FLR - FLR SYSTEM

MODEL: B70-13-11

DRAWN BY:
 NDC

SCALE:
 NTS

DRAWING NO.:

SHT. 1 OF 1

ISSUE DATE:
 08/29/09

DTL-01