

COLOR SELECTOR	
BLACK _____	BROWN _____
BEIGE _____	GRAY _____
WHITE _____	

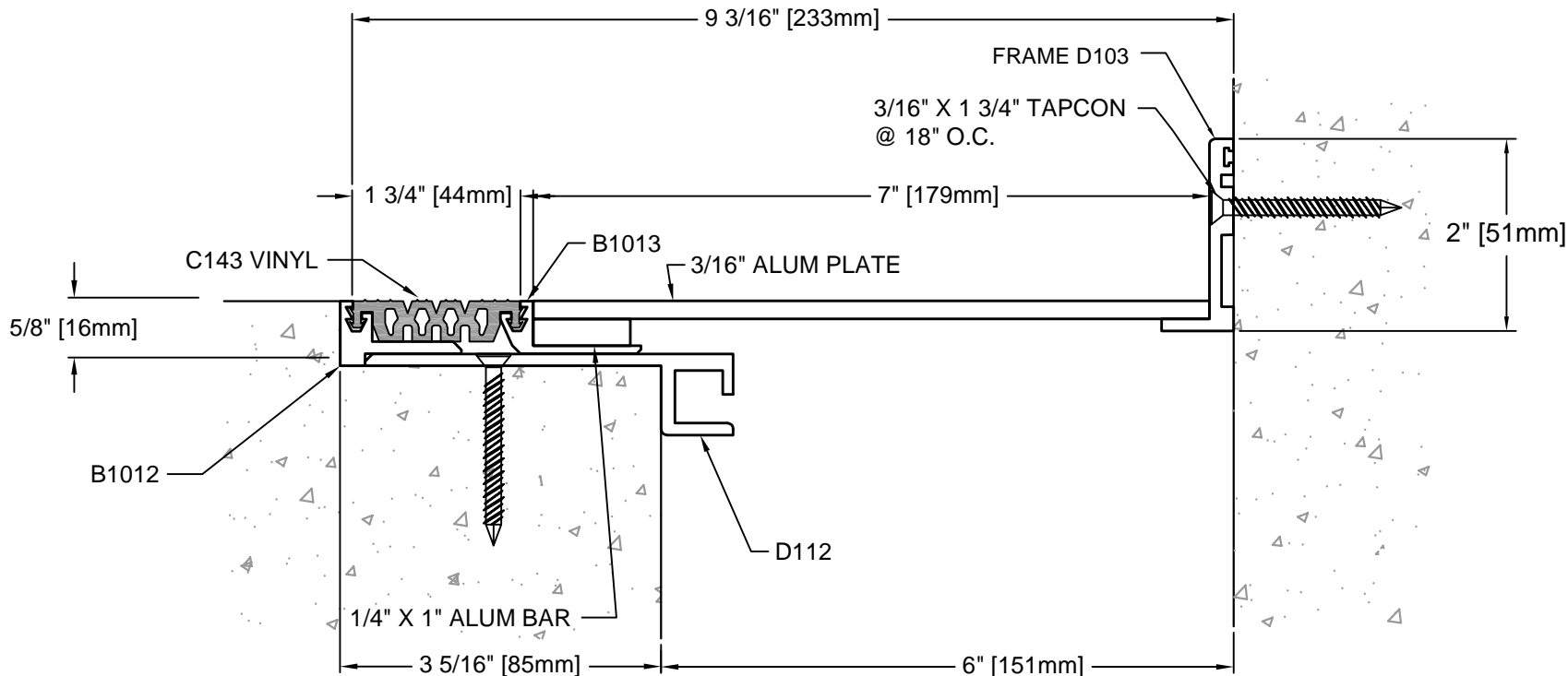

DESCRIPTION: FLOOR-TO-WALL
ALUMINUM: 6063-T5 EXTRUSION
VINYL: 70 DURO. PVC
EXPOSED FINISH: MILL
MOVEMENT: +/- 50% JOINT WIDTH
STOCK LENGTHS: 10'-0"

B60-33-11
REV. 01/08



**Architectural Art
MANUFACTURING**

Division of Pittcon Architectural Metals, LLC
283 SWANSON DRIVE, STE 103
LAWRENCEVILLE, GA 30043
PH: (678) 680-7373 FAX: (678) 735-0085
TOLL FREE: (800) 835-0028 web: www.archart.com

RIGHTS OF DESIGN

All rights of design, detail, engineering and/or invention contained herein are the property of Architectural Art Mfg. and hereby are the property and are not to be reproduced or provided to any other party. Architectural Art Mfg. reserves the right to amend or withdraw any information contained herein without notice and will not be liable for any inaccuracy or ambiguity of said information.

INTERIOR FLOOR TO WALL

MODEL: B60-33-11

DRAWN BY:
NDC

SCALE:
NTS

DRAWING NO.:

SHT. 1 OF 1

ISSUE DATE:
08/30/09

DTL-01