

COLOR SELECTOR	
BLACK _____	BROWN _____
BEIGE _____	GRAY _____
WHITE _____	

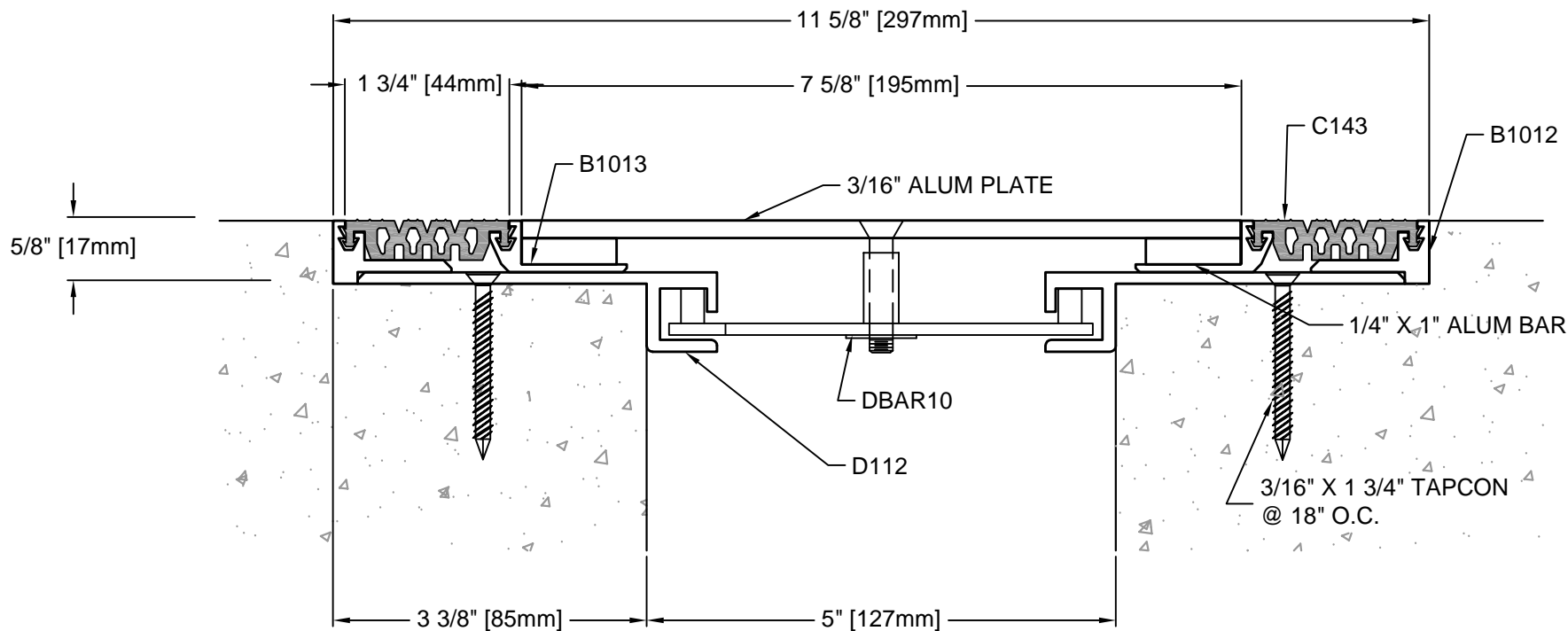

DESCRIPTION: FLOOR-TO-FLOOR  
ALUMINUM: 6063-T5 EXTRUSION  
VINYL: 70 DURO. PVC  
EXPOSED FINISH: MILL  
MOVEMENT: +/- 50% JOINT WIDTH  
STOCK LENGTHS: 10'-0"

**B50-16-11**  
REV. 01/08



**Architectural Art  
MANUFACTURING**

Division of Pittcon Architectural Metals, LLC  
283 SWANSON DRIVE, STE 103  
LAWRENCEVILLE, GA 30043  
PH: (678) 680-7373 FAX: (678) 735-0085  
TOLL FREE: (800) 835-0028 web: www.archart.com

**RIGHTS OF DESIGN**

All rights of design, detail, engineering and/or invention contained herein are the property of Architectural Art Mfg. and hereby are the property and are not to be reproduced or provided to any other party. Architectural Art Mfg. reserves the right to amend or withdraw any information contained herein without notice and will not be liable for any inaccuracy or ambiguity of said information.

**INTERIOR FLR - FLR SYSTEM**

MODEL: B50-16-11

DRAWN BY:  
NDC

SCALE:  
NTS

DRAWING NO.:

SHT. 1 OF 1

ISSUE DATE:  
08/29/09

**DTL-01**