

COLOR SELECTOR	
BLACK _____	BROWN _____
BEIGE _____	GRAY _____
WHITE _____	

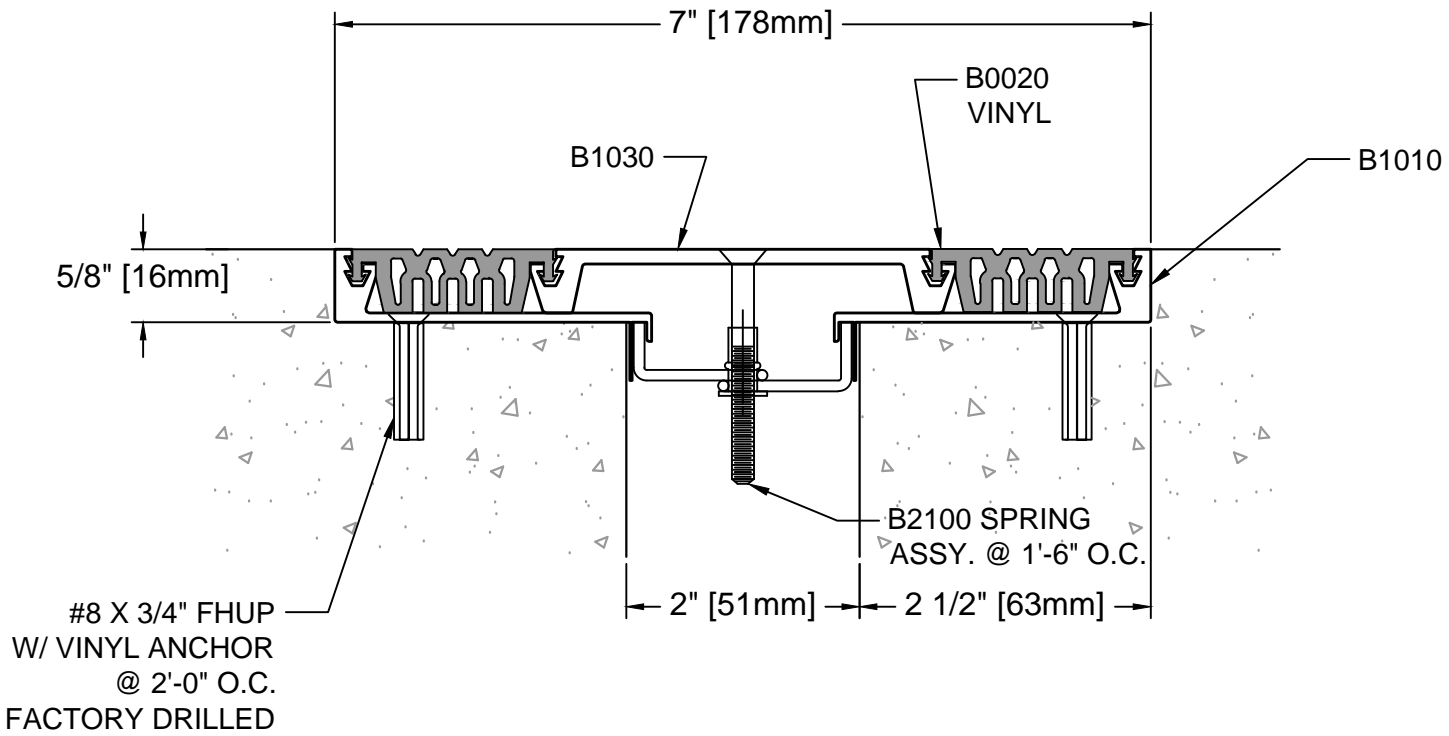

DESCRIPTION: FLOOR-TO-FLOOR
 ALUMINUM: 6063-T5 EXTRUSION
 FINISH: MILL
 ALLOWABLE LOAD: 738 LB/LF @ MAX. OPENING
 MOVEMENT: +/- 50% JOINT WIDTH
 STOCK LENGTHS: 20'-0"

B20-16-11
 REV. 08/08



**Architectural Art
 MANUFACTURING**

Division of Pittcon Architectural Metals, LLC
 283 SWANSON DRIVE, STE 103
 LAWRENCEVILLE, GA 30043
 PH: (678) 680-7373 FAX: (678) 735-0085
 TOLL FREE: (800) 835-0028 web: www.archart.com

FLOOR-FLOOR JOINT COVER

MODEL: B20-16-11		
DRAWN BY: NDC	SCALE: NTS	DRAWING NO.: DTL-01
SHT. 1 OF 1	ISSUE DATE: 08/06/2009	

NO.	DESCRIPTION	BY	DATE

REVISIONS
 The information contained herein is the proprietary property of **ARCHITECTURAL ART MFG.**, Division of Pittcon Architectural Metals, LLC. No portion of it may be reproduced by any means or used in any form except for the purpose for which it was furnished. All rights of design and invention are hereby reserved. We reserve the right to make changes in the design at our discretion.