

COLOR SELECTOR	
BLACK _____	BROWN _____
BEIGE _____	GRAY _____
WHITE _____	

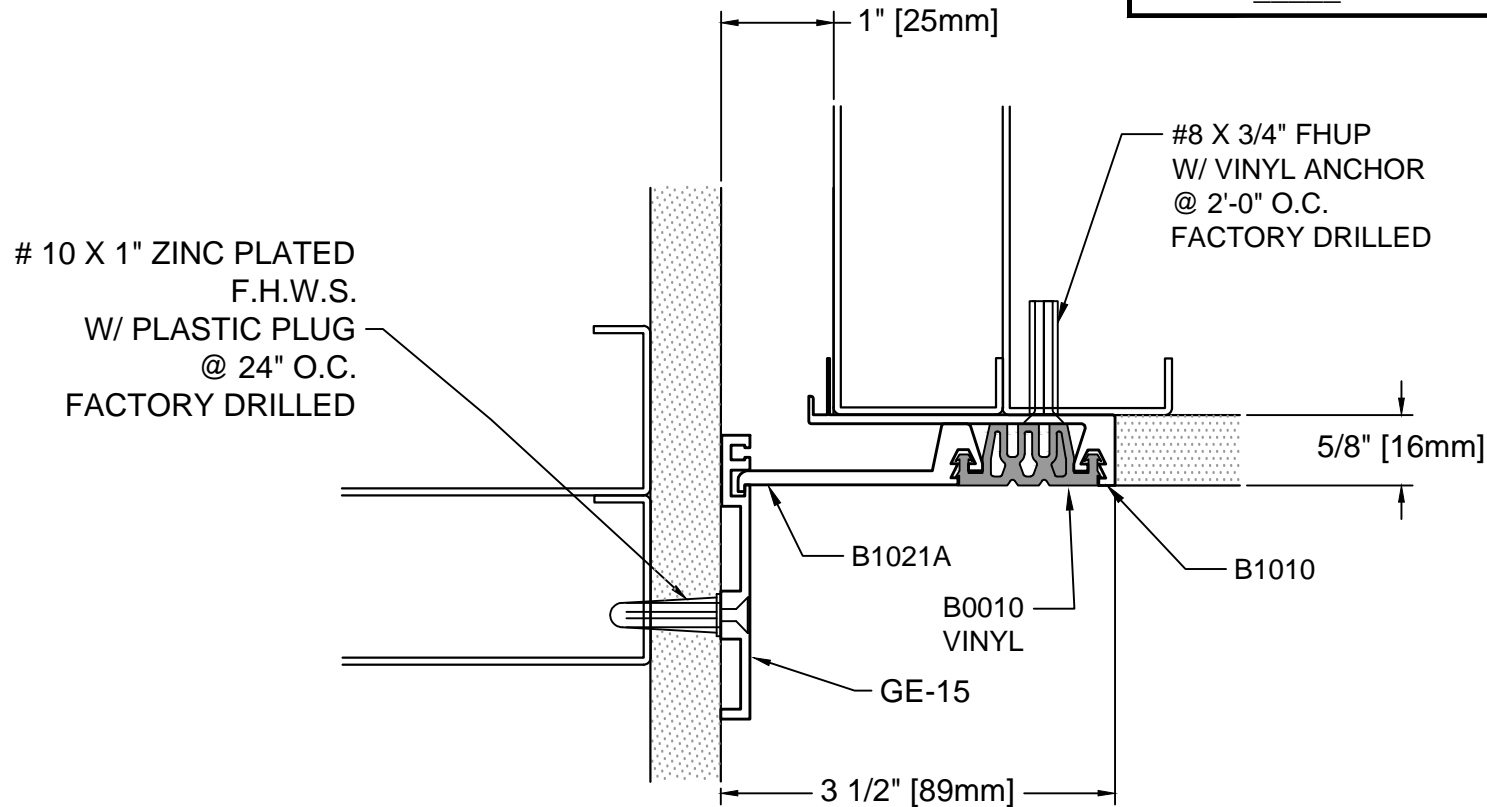

DESCRIPTION: CORNER WALL  
 ALUMINUM: 6063-T5 EXTRUSION  
 FINISH: CLEAR ANODIZED  
 ALLOWABLE LOAD: NOT DESIGNED FOR STRUCTURAL LOADS  
 MOVEMENT: +/- 25% JOINT WIDTH  
 STOCK LENGTHS: 20'-0"

**B10-61-14**  
 REV. 08/08



**Architectural Art  
MANUFACTURING**

Division of Pittcon Architectural Metals, LLC  
 283 SWANSON DRIVE, STE 103  
 LAWRENCEVILLE, GA 30043  
 PH: (678) 680-7373 FAX: (678) 735-0085  
 TOLL FREE: (800) 835-0028 web: www.archart.com

**CORNER WALL JOINT COVER**

MODEL: B10-61-14

DRAWN BY:  
NDC

SCALE:  
NTS

DRAWING NO.:

**DTL-01**

SHT. 1 OF 1

ISSUE DATE:  
08/05/2009

NO.	DESCRIPTION	BY	DATE

REVISIONS

The information contained herein is the proprietary property of **ARCHITECTURAL ART MFG.**, Division of Pittcon Architectural Metals, LLC. No portion of it may be reproduced by any means or used in any form except for the purpose for which it was furnished. All rights of design and invention are hereby reserved. We reserve the right to make changes in the design at our discretion.